

The Promise of RFID, Zigbee, and Sensor-Based Networks

The Grand Unification

Interop 2005

Mandalay Bay Convention Center

Las Vegas, NV

Jon Adams

Director, Wireless Technology and Strategy
Wireless and Mobile Systems Group



Introduction

Freescale Semiconductor

- **Established leader with a broad portfolio of products and clients**
- **Over 22,000 talented employees in 30 countries around the world**
- **Roots of our newly independent public company extend all the way back to 1953 as Motorola's Semiconductor Products Sector**
- **2004 revenue of \$5.7 billion, one of the largest semiconductor companies in the world**

Jon Adams

- **Director of Radio Technology and Strategy**
 - Primary focus on non-cellular wireless, including WiFi, WiMax, UWB, ZigBee, others
- **ZigBee Alliance Board of Directors**
- **President, UWB Forum**
- **Voting Member, IEEE 802.11, 802.15 and 802.16 Working Groups**

The Grand Unification – What's that all about?

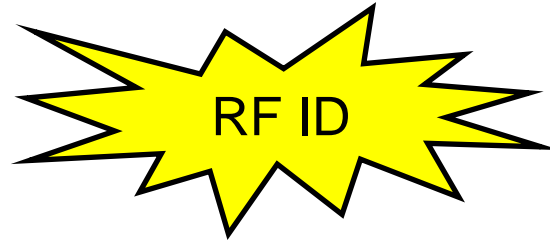
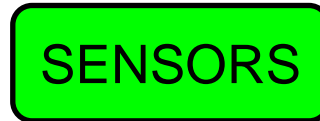
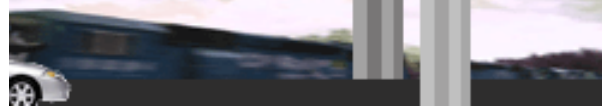

Home/Light Commercial Spaces

HOME AND DIAGNOSTICS ZIGBEE EXAMPLES

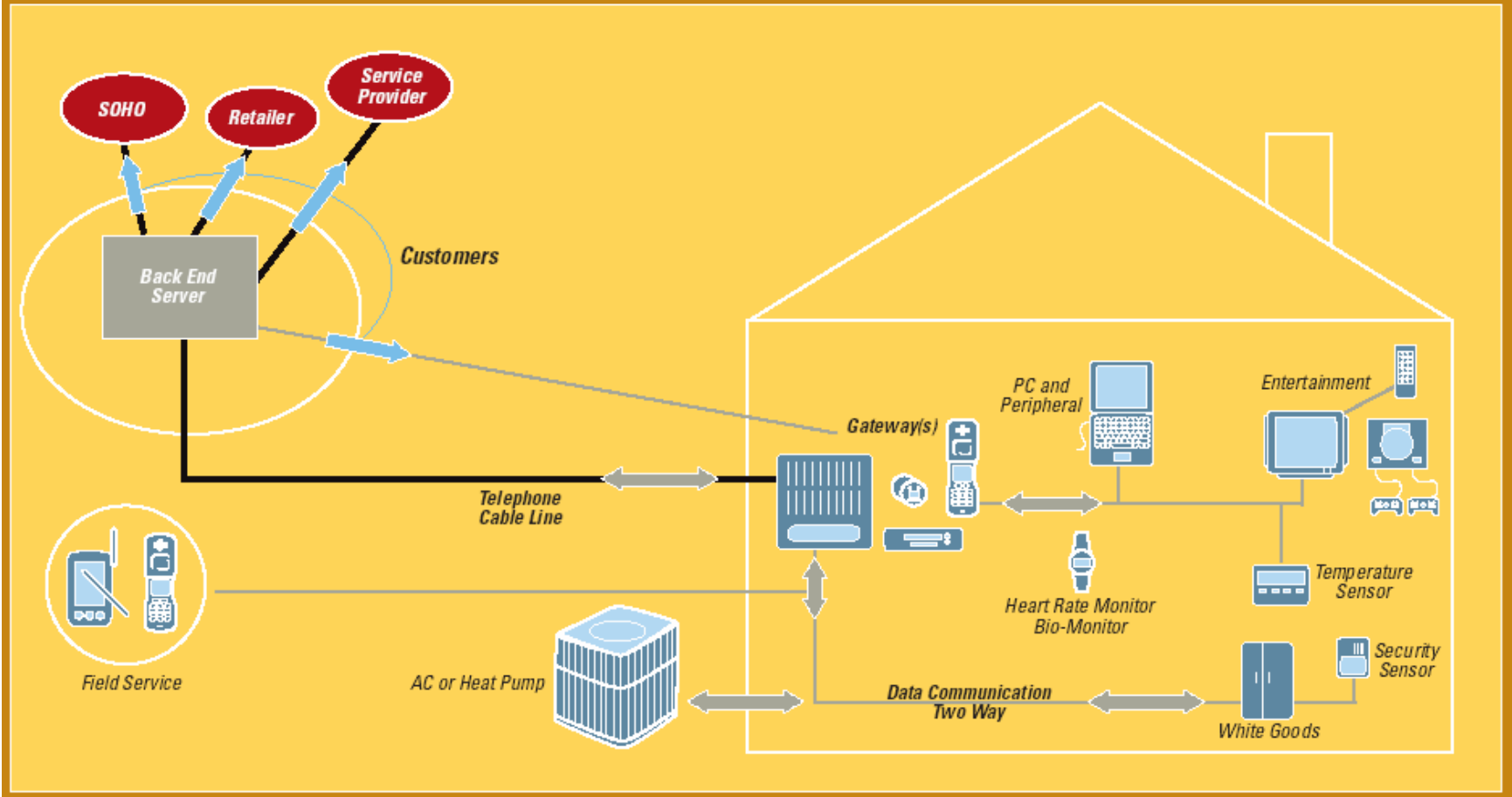

ZigBee in the Industrial/Commercial Space

INDUSTRIAL PRODUCT ZIGBEE EXAMPLES

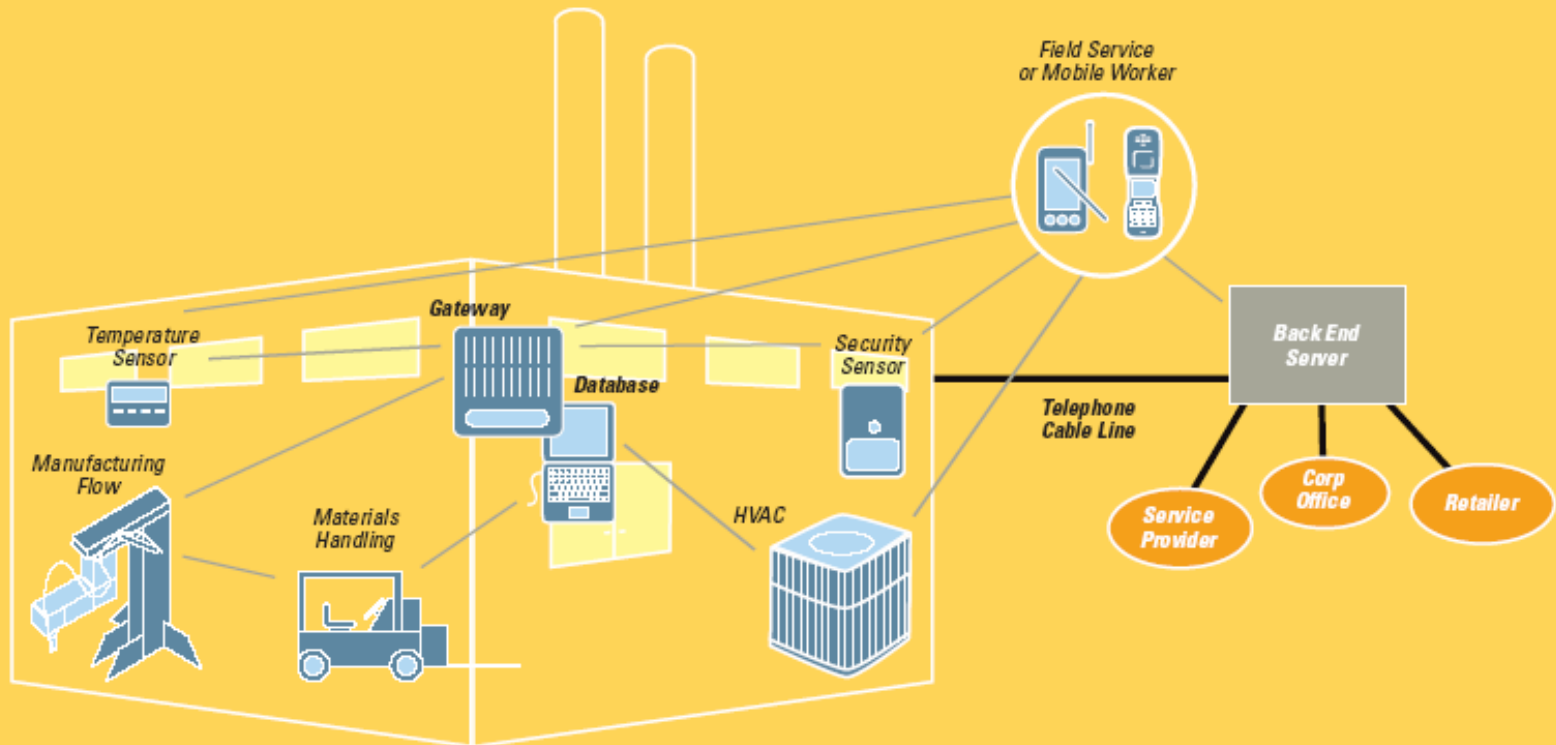

ZigBee is Mesh Networking

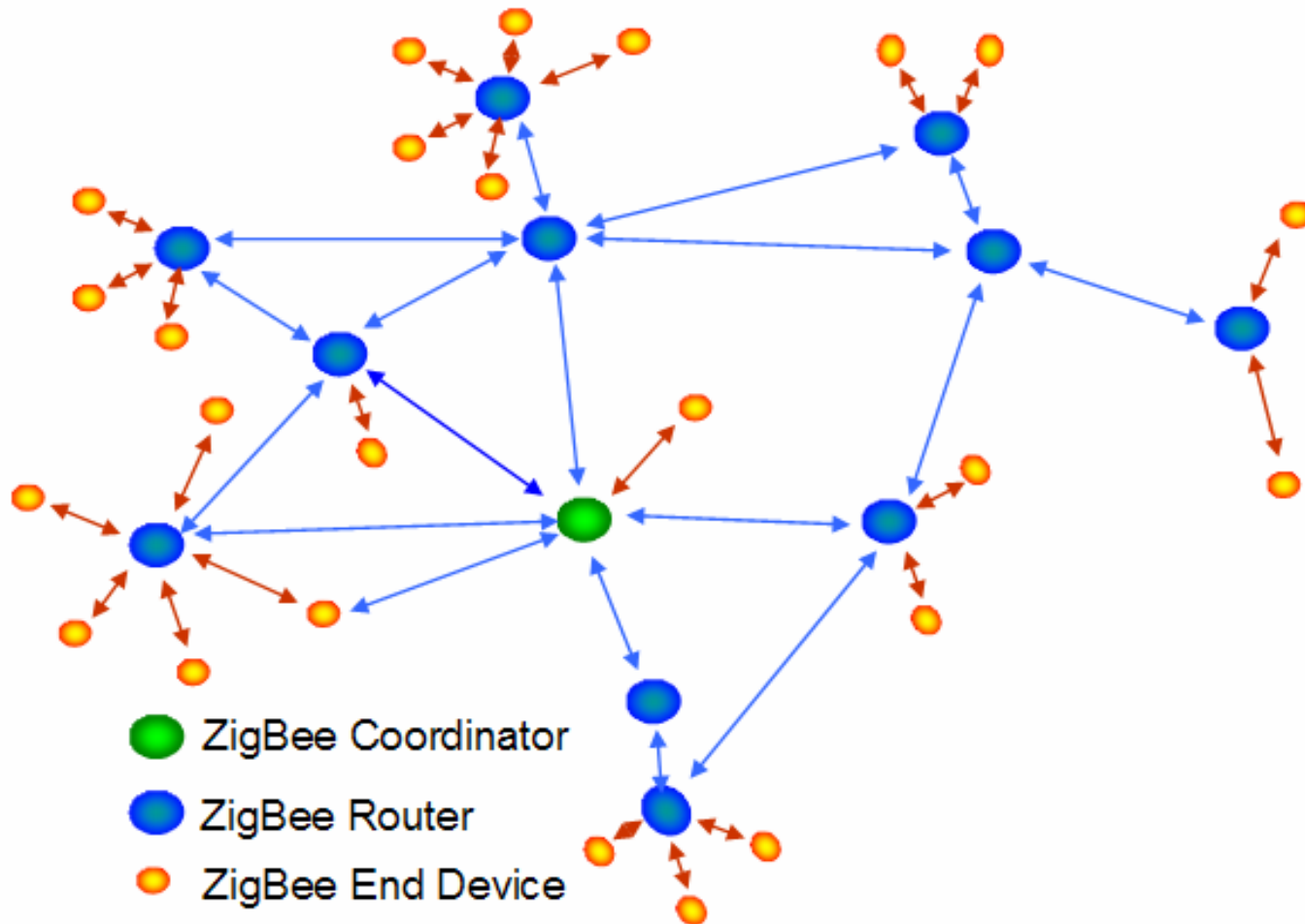

System Simplicity and Flexibility

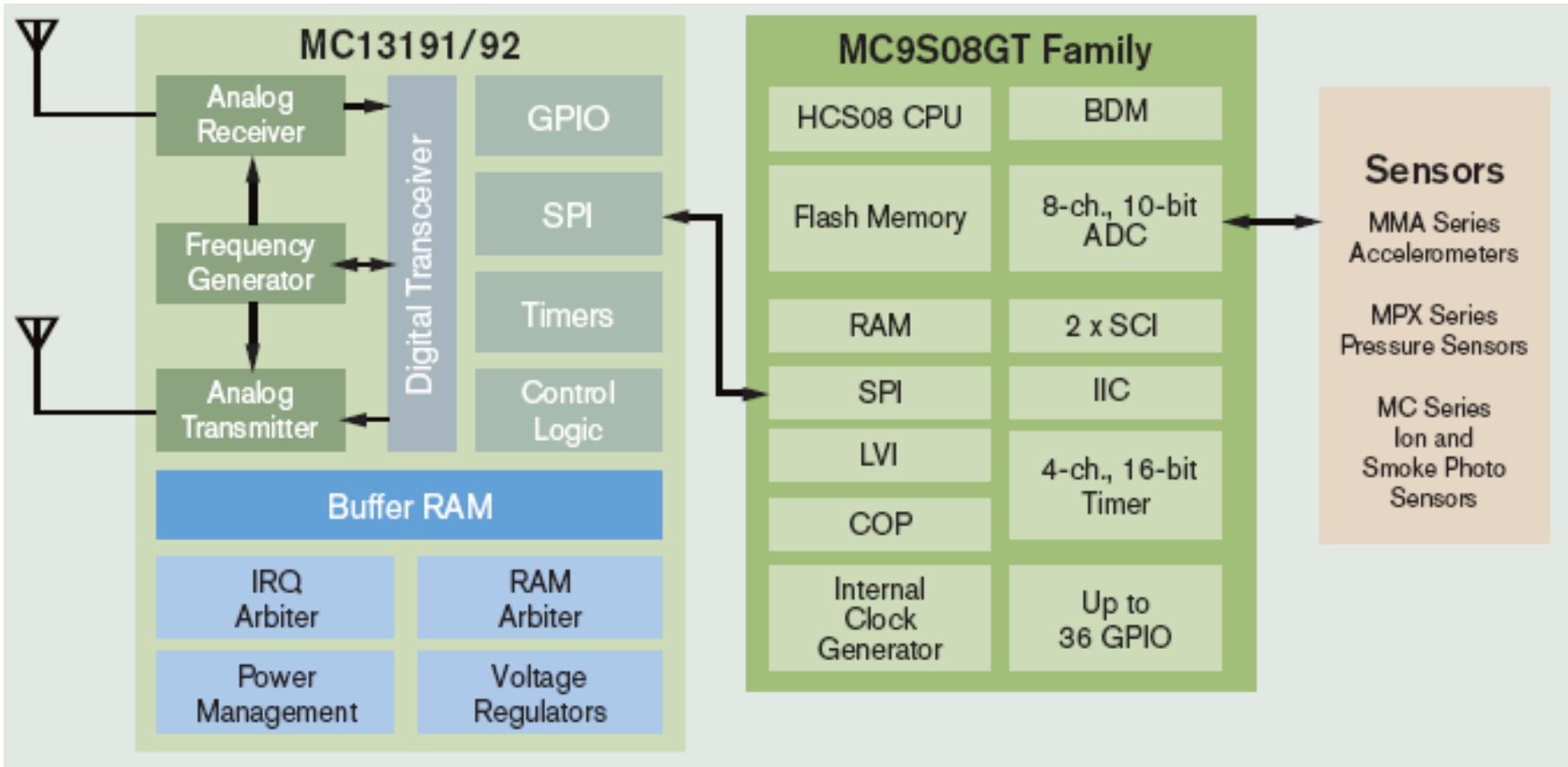

See www.freescale.com/zigbee for detailed information

