

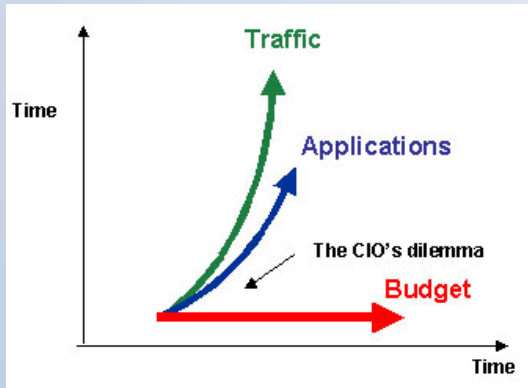

# NORTEL NETWORKS

BUSINESS WITHOUT BOUNDARIES

## Meeting The Challenges of Enterprise Networking



The CIO Challenge

**Tony Rybczynski**  
Director of Strategic Enterprise  
Technologies

# Towards The Real-Time Enterprise

## Customer Service Apps

- Self-serve and agent-assisted contact
- Integration with back-office systems via Web Services

## Communication-intensive Apps

- Delivering productivity through always-on connectivity

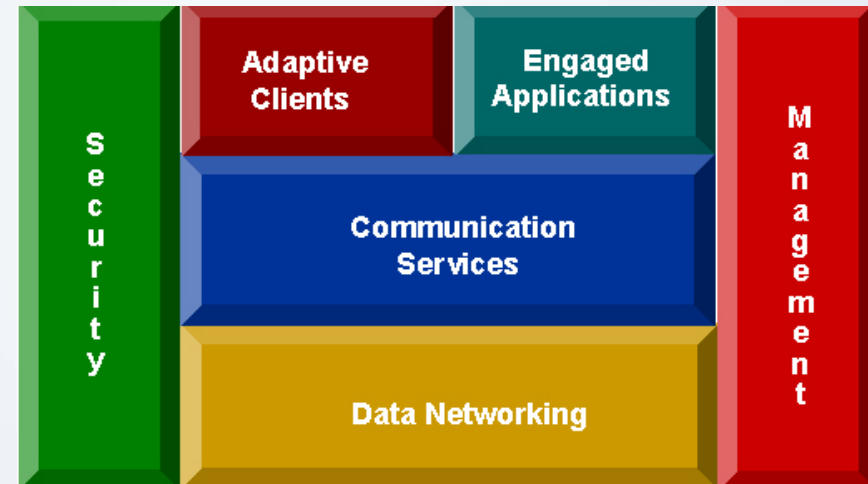

Architecture for the Converged Enterprise (ACE)

## Business Operations

- SCM, ERP, HR

## Engaged Apps

- Are the real source of business value
- Are converged
- Are anticipatory, media adaptive and real-time
- Leverage communications services

# ... Anytime... Anywhere



“Computer:  
Where is Dr  
Crusher?”

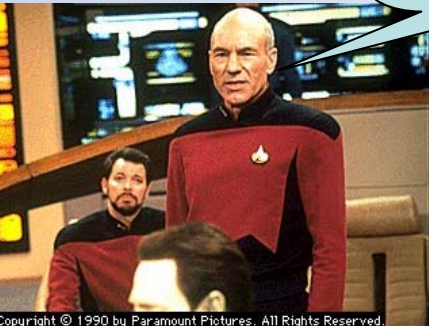

Copyright © 1990 by Paramount Pictures. All Rights Reserved.



©1994 Paramount Pictures



“Dr Crusher is  
in Sickbay.”

**These drive secure converged WLANs and  
enterprise-wide roaming and reliability**



**Communication Services**

# Interactive Web

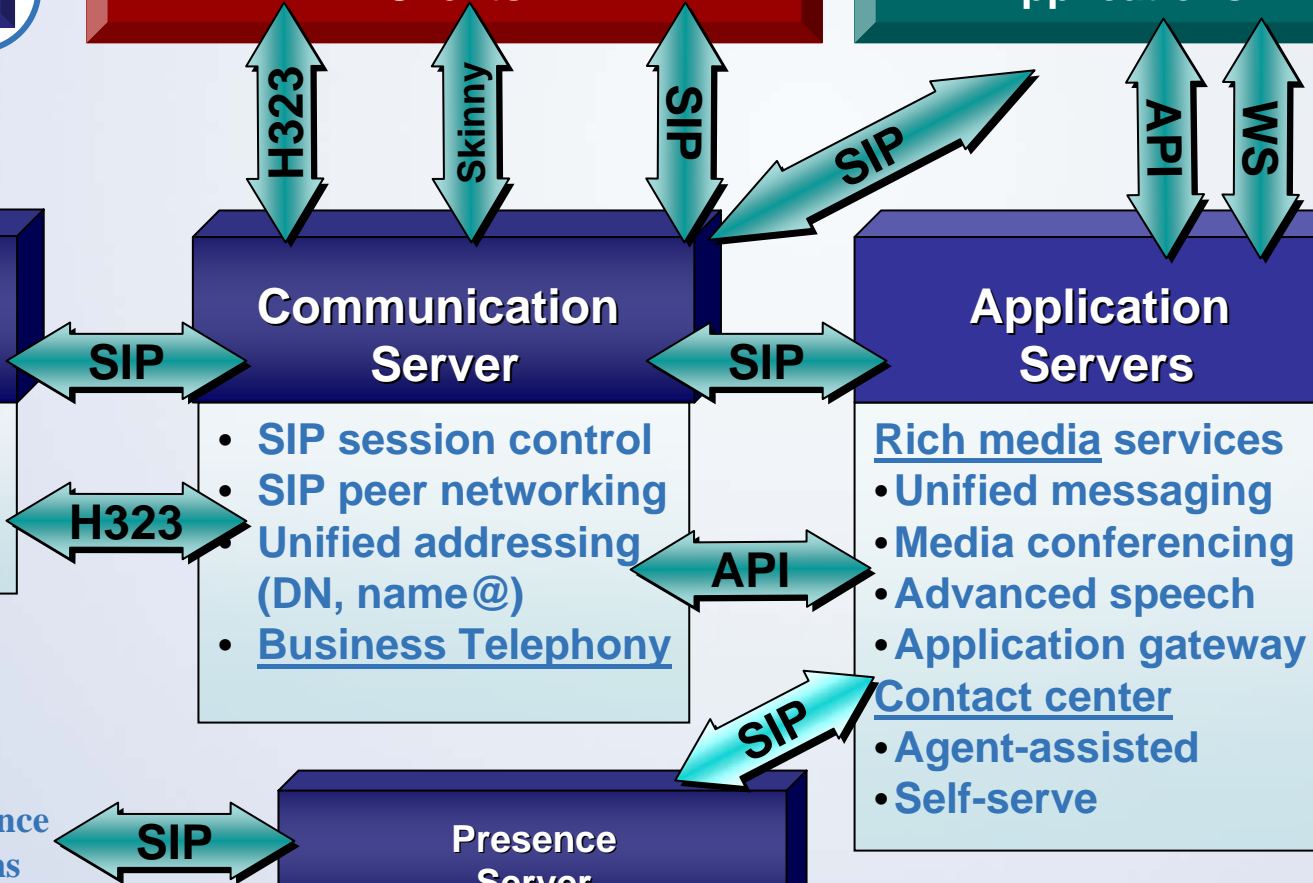
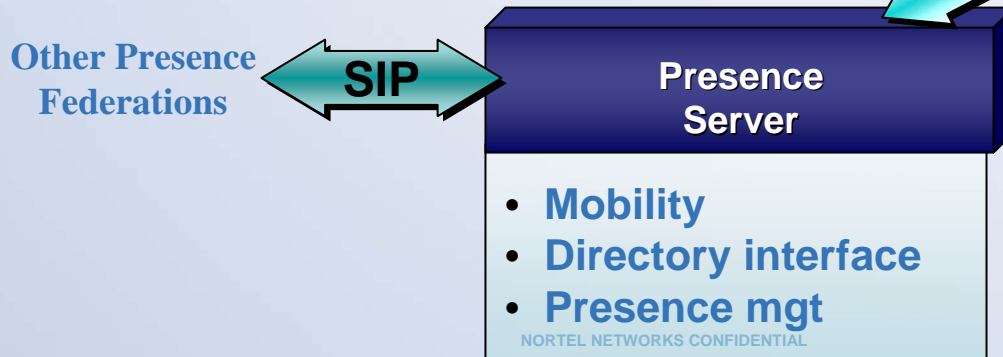
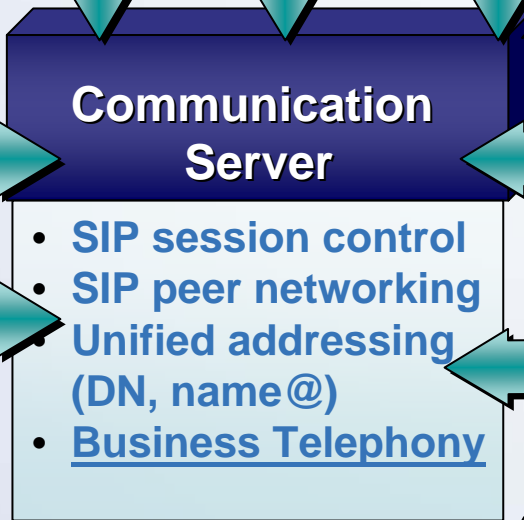
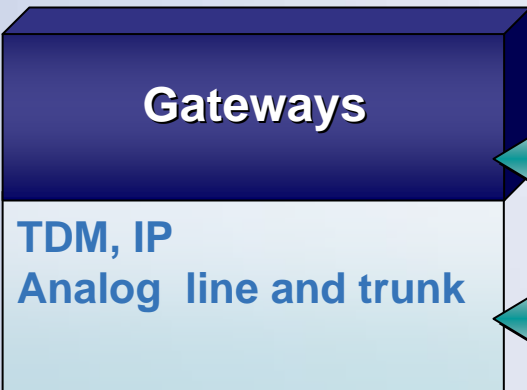
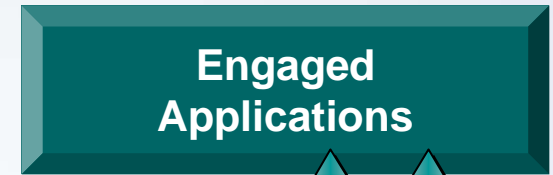

# Business Continuity

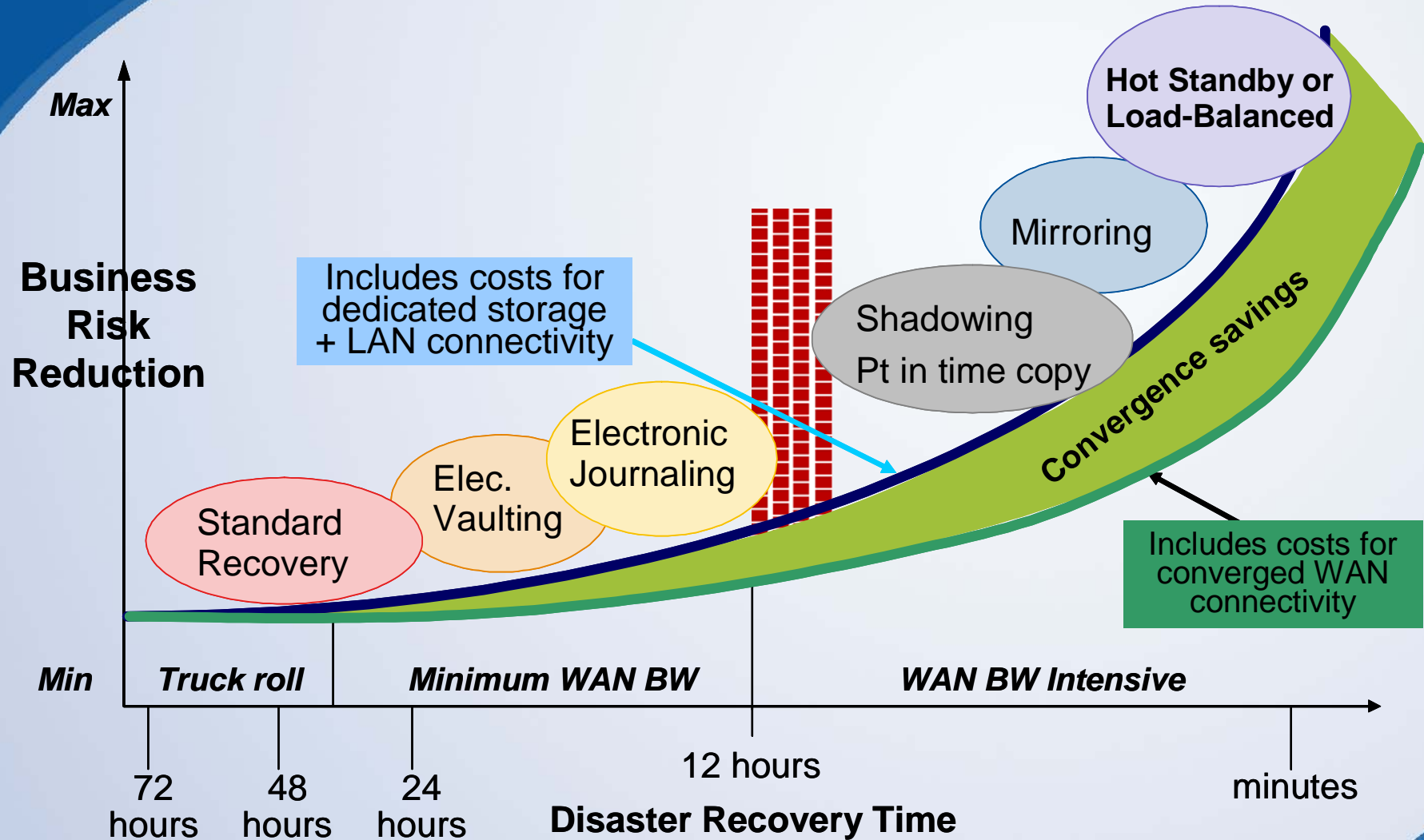

**Needs for Storage... AND Applications ... AND Services**

# Ethernet Everywhere ...Where You Can

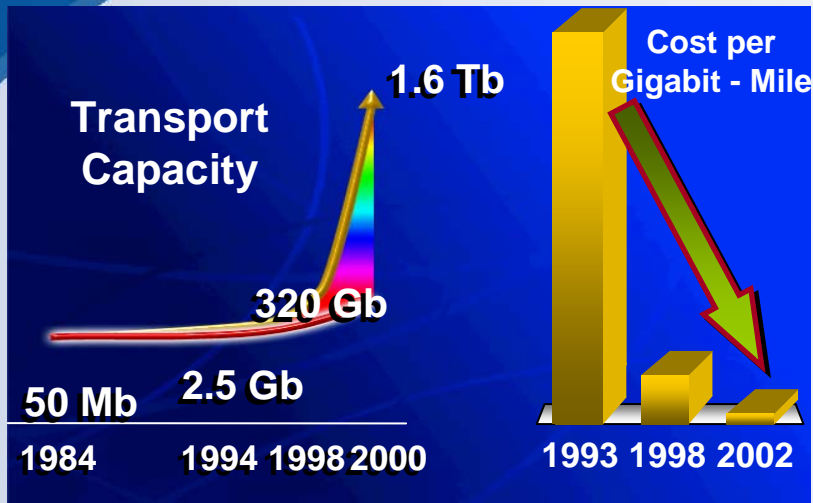

**Ethernet  
and  
Optical**

**Reliability and Scalability of Optics +  
Simplicity and Speed of Ethernet**

## **Simplification is profound**

- **Better interface price/performance with scalable bandwidth**
- **Centralization of resources (servers, firewalls, routers)**

## **Choices**

- **Roll your own (next gen SONET, DWDM, fiber)**
- **New service options (Ethernet private lines and LANs, virtual private lines and LANs)**

# VPN Technology Map

## VPNs

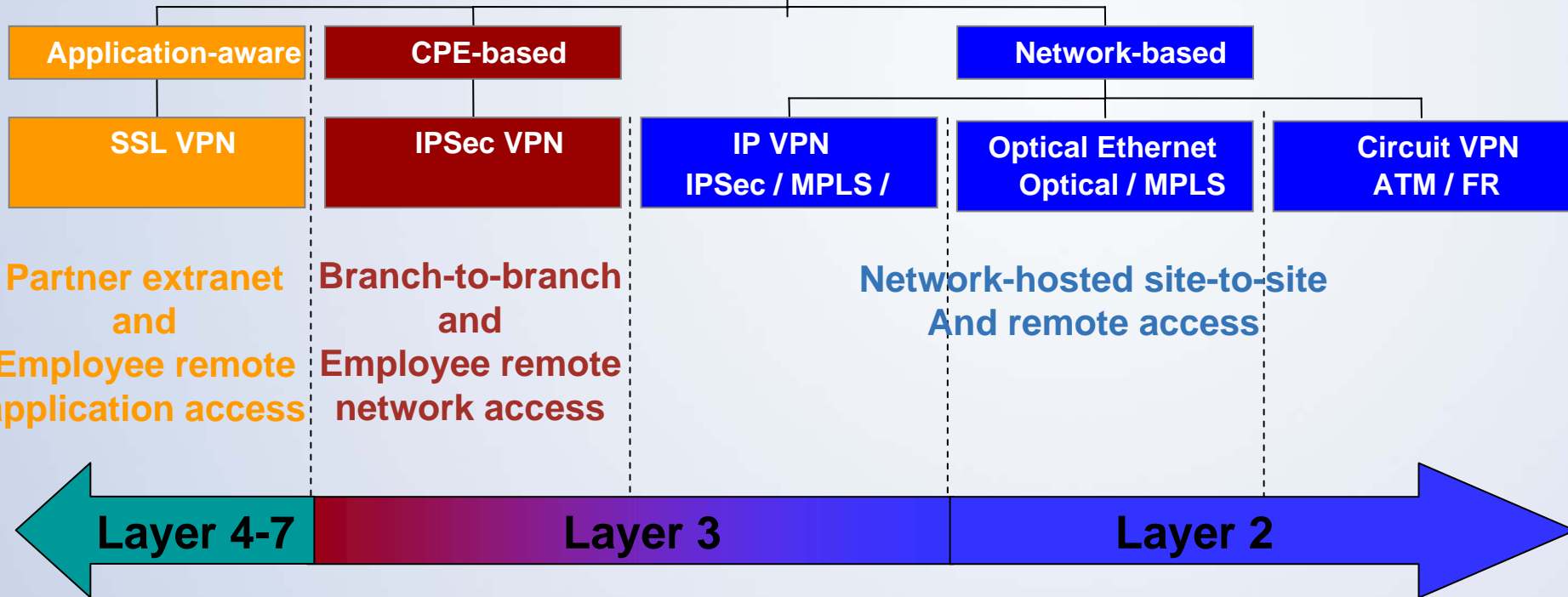

- **Inter-site: Ethernet VPN if you can; L3 VPN if you must**
- **Remote access: integrated IPSec and SSL VPNs**
- **Security a must in L3 VPNs**
- **Multiple carriers and services can be leveraged for optimal price/performance and reliability**

# Its about Convergence

## Network, Communications, Application and Business

### Convergence for:

- Reduced cost of ownership
- Increased productivity
- Innovation in customer experience

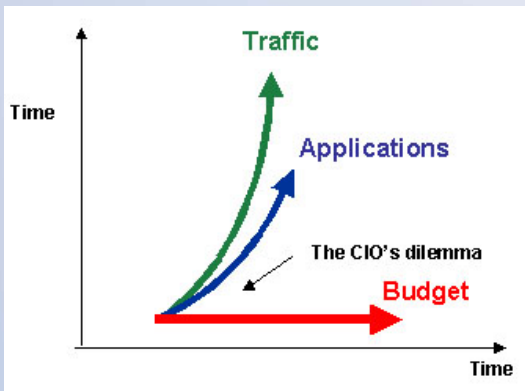

## Application support:

Real-time, anticipatory and media-adaptive  
engaged apps

Anytime, anywhere communications

Networked everything

## Network optimization:

IP/Ethernet/optical optimization

Dynamic WAN capacity- Optical Ethernet if  
you can; L3-7 VPNs if you must

Converged WLANs

Simplified high performance campus

N-1 redundancy and fast recovery

Security in network DNA

SIP across business telephony, rich media  
and customer contact



*Thank You*